



## **IDS-311F/IDS-312(+)/322(+)/342(+)** **Industrial Device Server**

### **User Manual**

**Version 1.1**

**November, 2017**

[www.oring-networking.com](http://www.oring-networking.com)

## **COPYRIGHT NOTICE**

Copyright © 2016 ORing Industrial Networking Corp.

All rights reserved.

No part of this publication may be reproduced in any form without the prior written consent of ORing Industrial Networking Corp.

## **TRADEMARKS**

 is a registered trademark of ORing Industrial Networking Corp.

All other trademarks belong to their respective owners.

## **REGULATORY COMPLIANCE STATEMENT**

Product(s) associated with this publication complies/comply with all applicable regulations. Please refer to the Technical Specifications section for more details.

## **WARRANTY**

ORing warrants that all ORing products are free from defects in material and workmanship for a specified warranty period from the invoice date (5 years for most products). ORing will repair or replace products found by ORing to be defective within this warranty period, with shipment expenses apportioned by ORing and the distributor. This warranty does not cover product modifications or repairs done by persons other than ORing-approved personnel, and this warranty does not apply to ORing products that are misused, abused, improperly installed, or damaged by accidents.

Please refer to the Technical Specifications section for the actual warranty period(s) of the product(s) associated with this publication.

## **DISCLAIMER**

Information in this publication is intended to be accurate. ORing shall not be responsible for its use or infringements on third-parties as a result of its use. There may occasionally be unintentional errors on this publication. ORing reserves the right to revise the contents of this publication without notice.

## **CONTACT INFORMATION**

### **ORing Industrial Networking Corp.**

3F., NO.542-2, Jhongjheng Rd., Sindian District, New Taipei City 231, Taiwan, R.O.C.

Tel: + 886 2 2218 1066 // Fax: + 886 2 2218 1014

Website: [www.oring-networking.com](http://www.oring-networking.com)

### **Technical Support**

E-mail: [support@oring-networking.com](mailto:support@oring-networking.com)

### **Sales Contact**

E-mail: [sales@oring-networking.com](mailto:sales@oring-networking.com) (Headquarters)

[sales@oring-networking.com.cn](mailto:sales@oring-networking.com.cn) (China)

# Table of Content

<b>Getting Started .....</b>	<b>4</b>
1.1 About IDS-312/322/342(+) .....	4
1.2 Software Features.....	4
1.3 Hardware Specifications.....	4
 <b>Hardware Overview.....</b>	 <b>6</b>
2.1 Front Panel.....	6
2.1.1 Ports and Connectors.....	6
2.1.2 LED.....	8
2.2 Top Panel .....	9
2.3 Rear Panel .....	10
 <b>Hardware Installation.....</b>	 <b>11</b>
3.1 DIN-rail Installation.....	11
3.2 Wall Mounting.....	12
3.2 Wiring.....	14
3.2.1 Grounding.....	14
3.2.2 Redundant Power Inputs .....	14
3.3 Connection .....	15
3.3.1 Cables.....	15
 <b>Management .....</b>	 <b>17</b>
4.1 DS-Tool .....	17
4.1.1 Install DS-Tool.....	17
4.1.2 Using DS-Tool .....	18
4.1.3 Configure Device Servers.....	19
4.1.4 Configure Serial Port .....	25
4.2 Web Management.....	34
4.2.1 System.....	35
4.2.1.1 Time (SNTP) .....	35
4.2.1.2 IP Configuration.....	37
4.2.1.3 User Authentication .....	39
4.2.2 Port Serial Setting .....	39
4.2.2.1 Serial Configuration.....	39
4.2.2.2 Port Profile .....	42
4.2.2.3 Service Mode .....	42

4.2.3	Management .....	46
4.2.3.1	Access IP Control .....	46
4.2.3.2	SMTP/SNMP Conf .....	47
4.2.3.3	System Event Conf.....	48
4.2.4	Save/Reboot .....	50
4.3	Configuration by SSH Console.....	51
4.3.1	Connect to DS.....	51

# Getting Started

## 1.1 About IDS-312/322/342(+)

The IDS-312(+)/322(+)/342(+) are industrial device servers with one, two, or four RS-232/422/485 ports and two LAN ports designed for converting signals between serial and Ethernet networks. It provides standard features of device servers such as TCP/IP interfaces and versatile operation modes including Virtual Com, Serial Tunnel, TCP Server, TCP Client, UDP. The device also supports Windows utility DS-Tool which allows you to configure multiple devices and set up the mappings of Virtual Com. The device can transfer data to five host PCs simultaneously for redundancy in case of Ethernet connection breakdown or host PC failure. Further, the device supports HTTPS, SSH, and SSL encryption to assure the security of critical data transmission. One of the Ethernet port on the IDS-312+/322+/342+ supports IEEE802.3af-compliant PoE PD (Power Device) function, making the device ideal for environment where cabling or power supply is difficult.

## 1.2 Software Features

- Supports five host devices including Virtual COM, TCP Server, TCP Client modes and four IP ranges
- Supports operating modes such as Virtual Com, Serial Tunnel, TCP Server, TCP Client, UDP
- Supports application-based QoS management
- NAT-pass through support for users to manage IDS-342+ through NAT router
- Ensure high levels of security with SSL data encryption, HTTPS/SSH, IP access control and IP white list
- Event warning by Syslog, Email, and SNMP trap
- Configurable by Web Interface and Windows utility
- Various Windows O.S. supported: Windows NT/2000/ XP/ 2003/VISTA(32/64bit)/ Windows 7(32/64bit)

## 1.3 Hardware Specifications

- 1, 2, or 4 x RS-232/422/485 serial ports
- 2 x 10/100Base-T(X) Ethernet ports (one PoE port provided by IDS-312+/342+)
- DIN-rail and wall-mount (IDS-312/322 models only) enabled
- Redundant DC power inputs
- Operating Temperature: -40 to 70°C
- Storage Temperature: -40 to 85°C

- Operating Humidity: 5% to 95%, non-condensing
- Casing: IP-30
- Dimensions: IDS-342(+): 66 (W) x 81 (D) x 95 (H) mm / IDS-312/322(+): 45 (W) x 81 (D) x 95 (H) mm

# Hardware Overview

## 2.1 Front Panel

### 2.1.1 Ports and Connectors

The device provides the following ports on the top panel. The Ethernet port on the device use RJ-45 connectors

Port	Description
<b>Copper port</b>	2 x 10/100Base-T(X) port (one is PoE-enabled)
<b>Serial port</b>	4 x DB9 serial ports

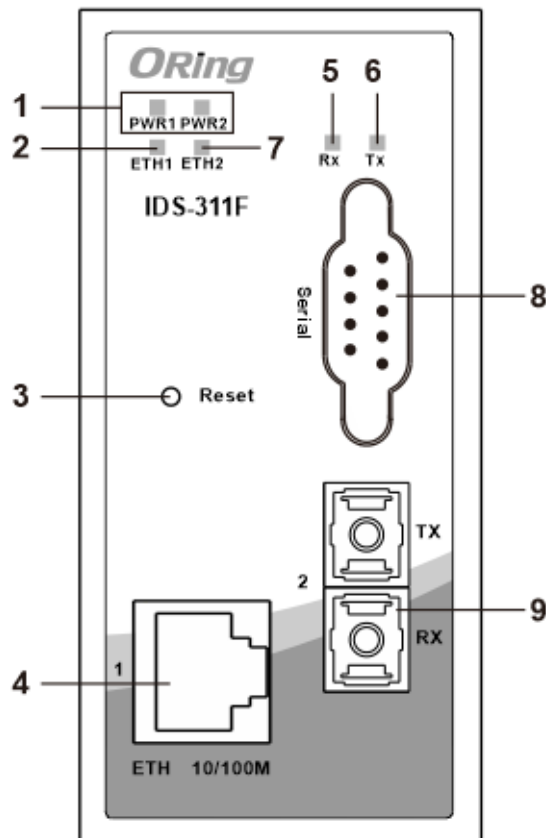

- 1. Power status indicators
- 2. LAN port connection indicators
- 3. Reset button
- 4. Ethernet port
- 5. Serial signal transmission status indicator
- 6. Serial signal reception status indicator
- 7. Fiber port status indicator
- 8. Serial port
- 9. SC fiber port

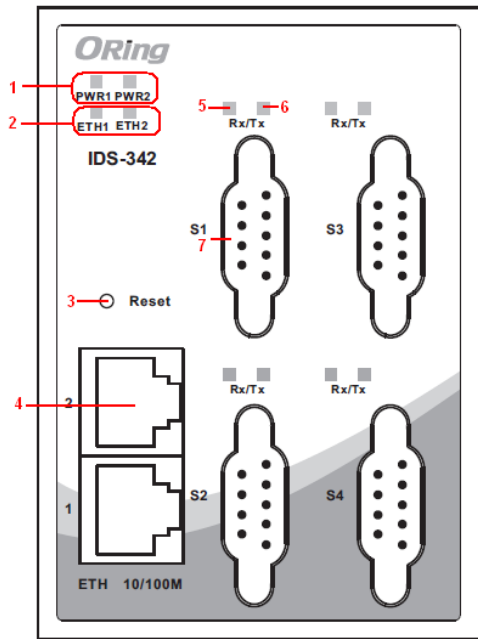

**IDS-342**

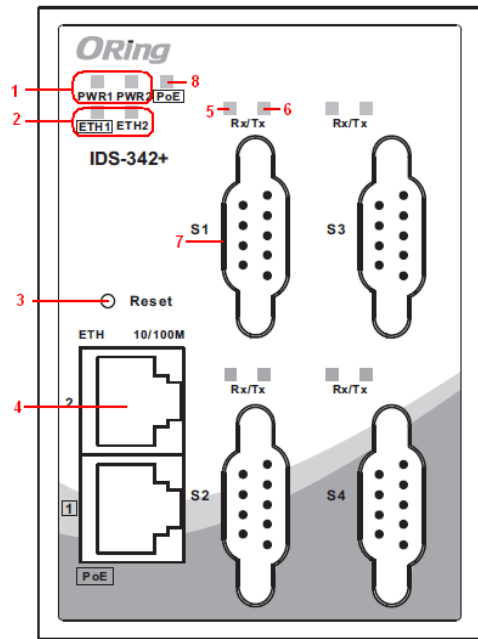

**IDS-342+**

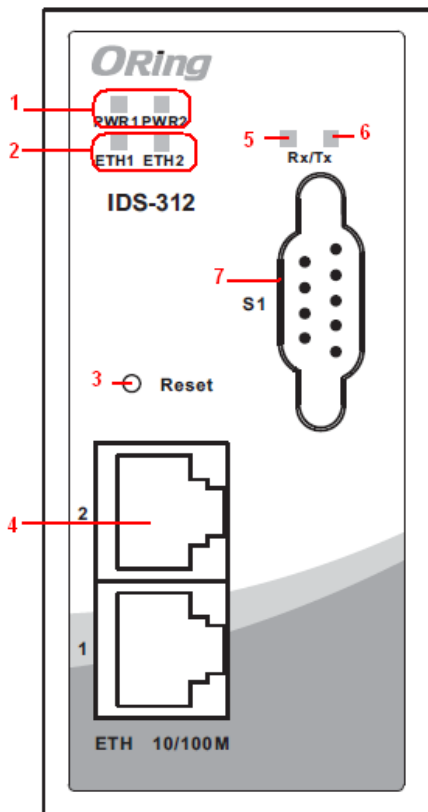

**IDS-312**

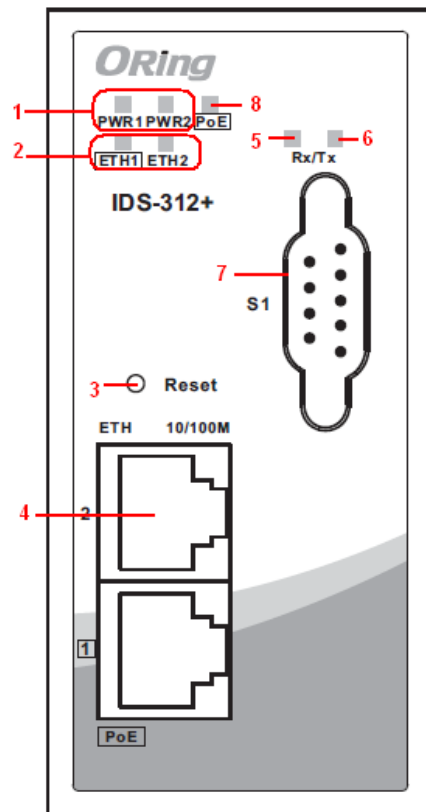

**IDS-312+**



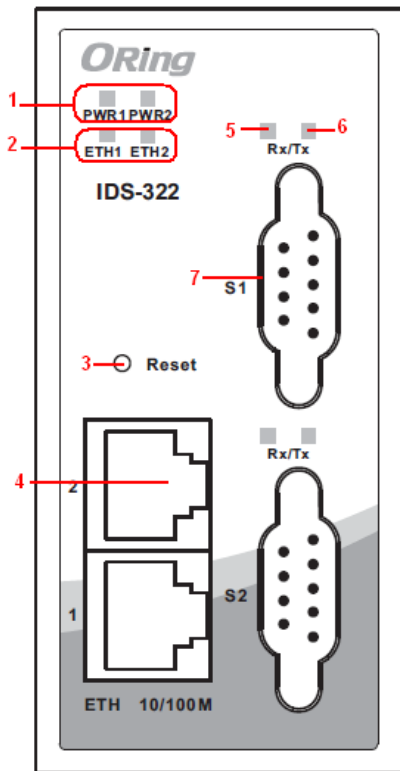

**IDS-322**

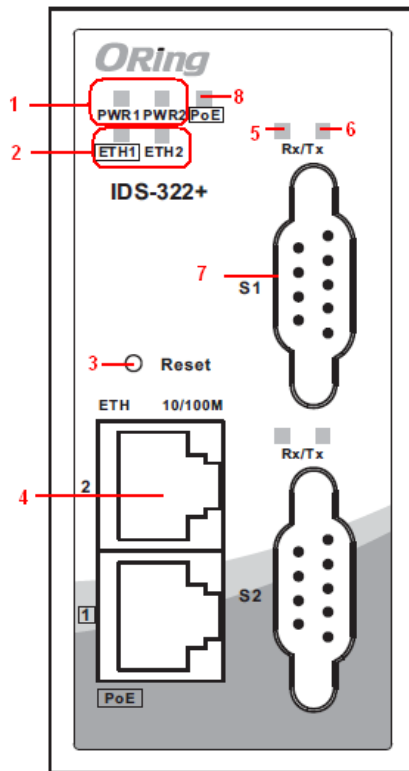

**IDS-322+**

- |   |  |
|---|--|
| <ul style="list-style-type: none"> <li>1. Power status indicators</li> <li>2. LAN port connection indicators</li> <li>3. Reset button</li> <li>4. Ethernet port (ETH 2 of IDS-312+/322+/342+ is PoE-enabled)</li> </ul> | <ul style="list-style-type: none"> <li>5. Serial signal transmission status indicator</li> <li>6. Serial signal reception status indicator</li> <li>7. Serial port</li> <li>8. PoE status indicator</li> </ul> |
|---|--|

**2.1.2 LED**

LED	Color	Status	Description
<b>PW1/2</b>	Green	On	Power is on and function normally
<b>ETH 1/2</b>	Green	On	Port is connected and running at 100Mbps
<b>TX / RX</b>	Red	On	Receiving data
	Green	On	Transmitting data
<b>PoE</b>	Green	On	Power is supplied over Ethernet cable

## 2.2 Top Panel

Below are the top panel components of the device:

1. Terminal blocks: PWR1, PWR2, Relay
2. Ground wire. For more information on how to ground the switch, please refer to [3.2.1 Grounding](#).

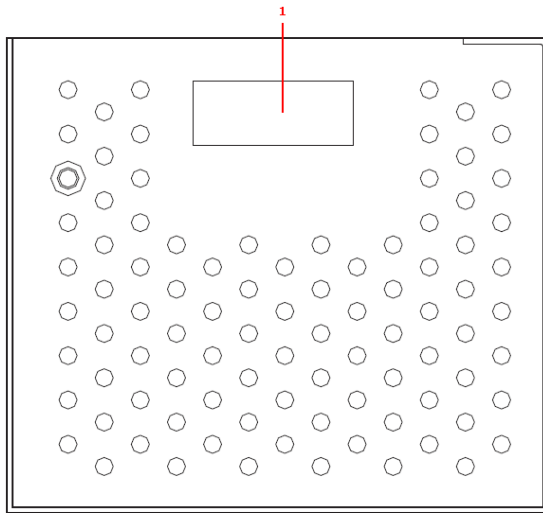

1. Terminal block for power connectors

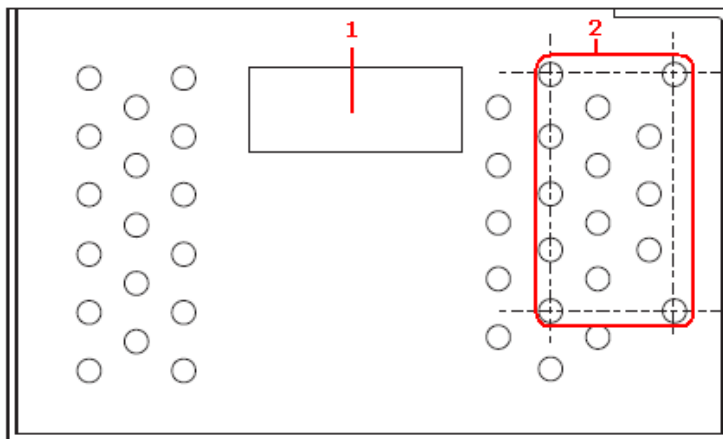

**IDS-342**

3. Terminal block
4. Wall-mount screw holes

**IDS-312/322**

## 2.3 Rear Panel

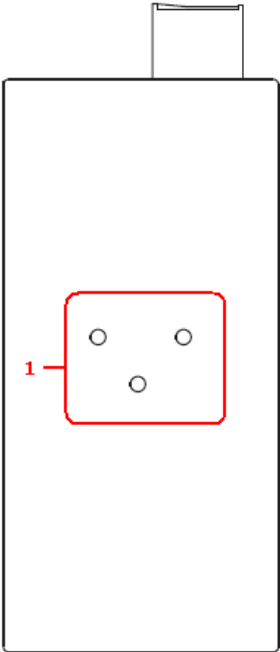

- 1. DIN-rail screw holes

# Hardware Installation

## 3.1 DIN-rail Installation

The devices come with a DIN-rail kit to allow you to fasten the device to a DIN-rail in any environments.

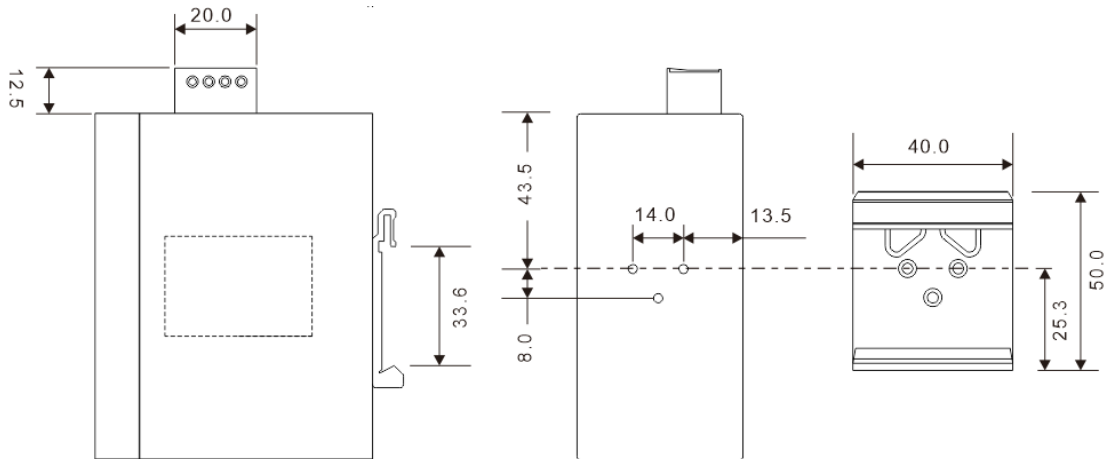

**IDS-311F**

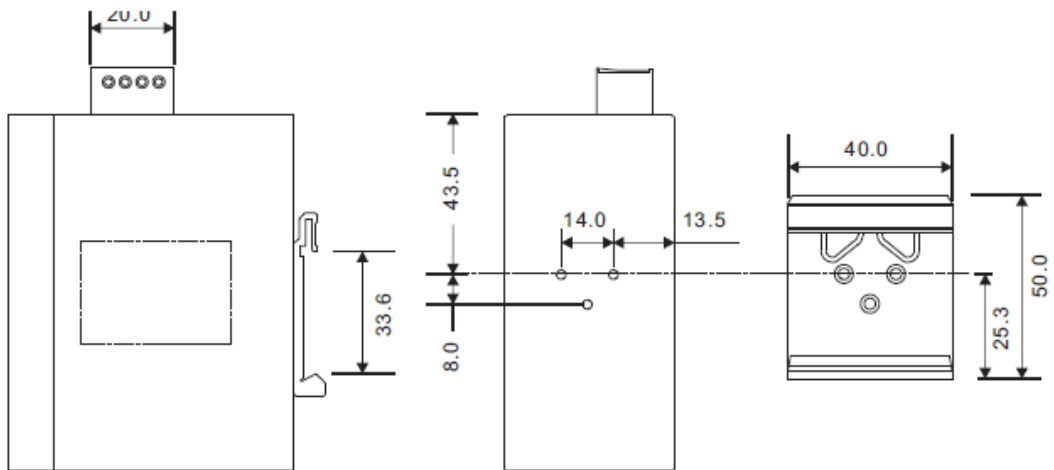

**IDS3-312/322**

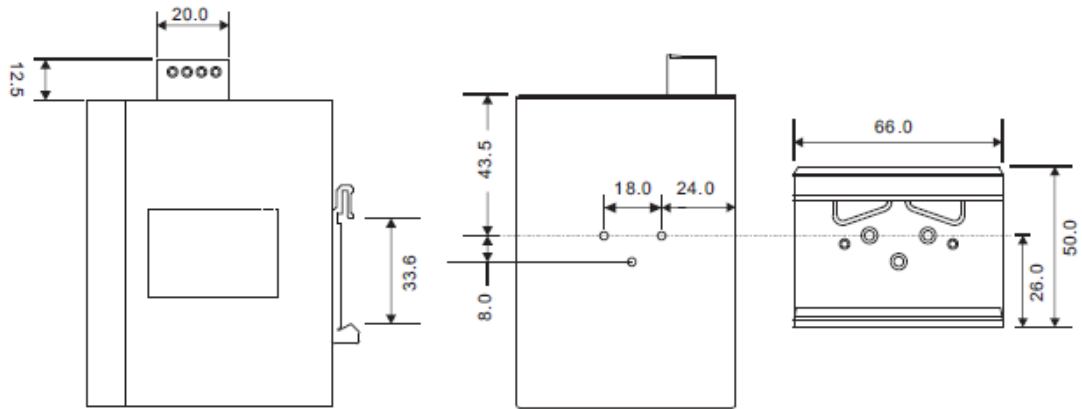

**IDS-342**

DIN-rail Kit Measurement (unit = mm)

Installing the device on the DIN-rail is easy. First, screw the Din-rail kit onto the back of the device, right in the middle of the back panel. Then slide the device onto a DIN-rail from the Din-rail kit and make sure the device clicks into the rail firmly.

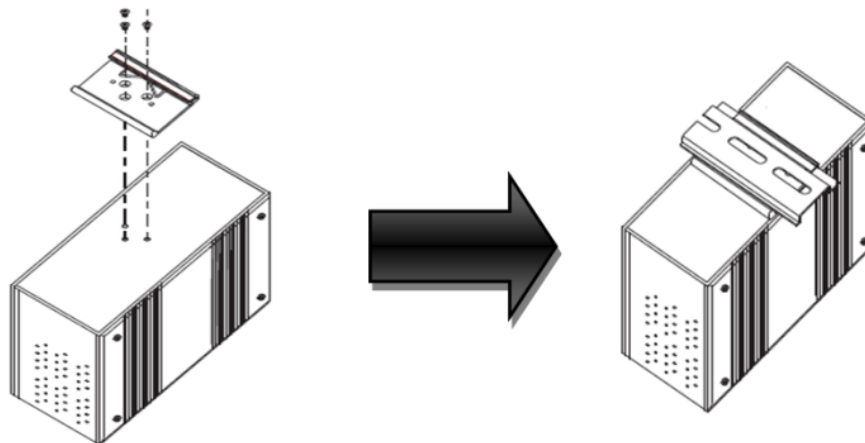

**3.2 Wall Mounting**

The IDS-312/322(+) support wall mounting, so they can be fixed to the wall via wall mount kits, which can be found in the package.

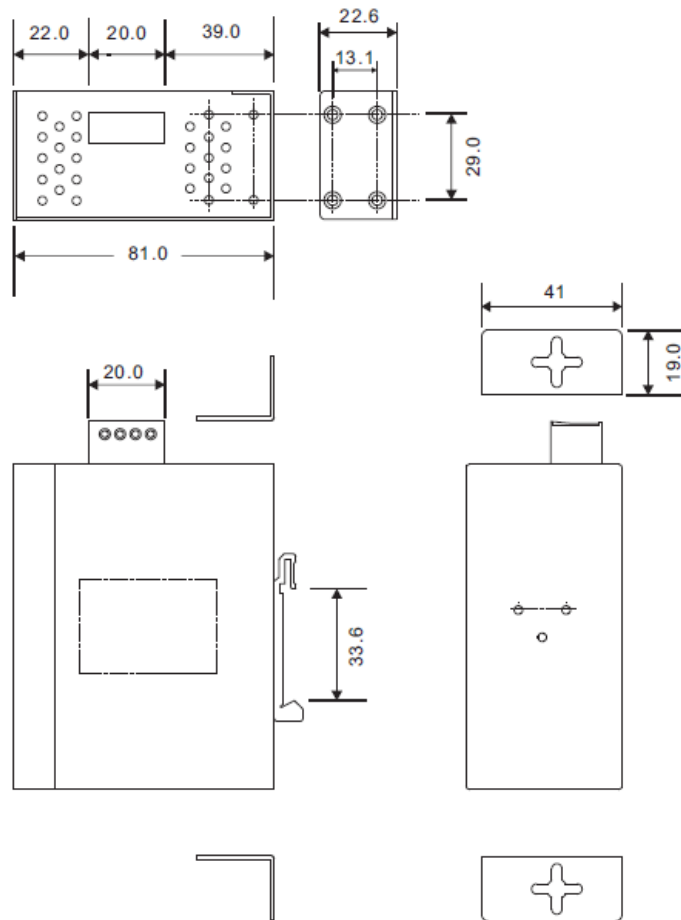

Wall-mount Kit Measurement (unit = mm)

Follow the steps below to install the device to a rack.

**Step 1:** Install the L-shape mounting kits provided in the package to the left and right of the device.

**Step 2:** With front brackets orientated in front of the rack, mount the device in the rack with four rack-mounting screws.

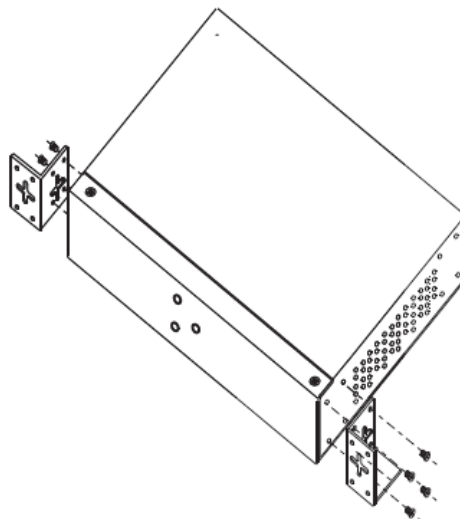

## 3.2 Wiring

---



### WARNING

Do not disconnect modules or wires unless power has been switched off or the area is known to be non-hazardous. The devices may only be connected to the supply voltage shown on the type plate.

---



### ATTENTION

1. Be sure to disconnect the power cord before installing and/or wiring your devices.
  2. Calculate the maximum possible current in each power wire and common wire. Observe all electrical codes dictating the maximum current allowable for each wire size.
  3. If the current goes above the maximum ratings, the wiring could overheat, causing serious damage to your equipment.
  4. Use separate paths to route wiring for power and devices. If power wiring and device wiring paths must cross, make sure the wires are perpendicular at the intersection point.
  5. Do not run signal or communications wiring and power wiring through the same wire conduit. To avoid interference, wires with different signal characteristics should be routed separately.
  6. You can use the type of signal transmitted through a wire to determine which wires should be kept separate. The rule of thumb is that wiring sharing similar electrical characteristics can be bundled together.
  7. You should separate input wiring from output wiring.
  8. It is advised to label the wiring to all devices in the system.
- 

### 3.2.1 Grounding

Grounding and wire routing help limit the effects of noise due to electromagnetic interference (EMI). Run the ground connection from the ground pin on the power module to the grounding surface prior to connecting devices.

### 3.2.2 Redundant Power Inputs

The device has two sets of DC power inputs on a 6-pin terminal block located on top of the device. Follow the steps below to wire the power input on the terminal block.

**Step 1:** insert the negative/positive wires into the V-/V+ terminals, respectively.

**Step 2:** to keep the wires from pulling loose, use a small flat-blade screwdriver to tighten the wire-clamp screws on the front of the terminal block connector.

## 3.3 Connection

### 3.3.1 Cables

#### 10/100BASE-T(X) Pin Assignments

The device has a standard Ethernet port. According to the link type, the device uses CAT 3, 4, 5, 5e UTP cables to connect to any other network devices (PCs, servers, switches, routers, or hubs). Please refer to the following table for cable specifications.

Cable Types and Specifications:

Cable	Type	Max. Length	Connector
10BASE-T	Cat. 3, 4, 5 100-ohm	UTP 100 m (328 ft)	RJ-45
100BASE-TX	Cat. 5 100-ohm UTP	UTP 100 m (328 ft)	RJ-45

With 10/100Base-T(X) cables, pins 1 and 2 are used for transmitting data, and pins 3 and 6 are used for receiving data.

10/100 Base-T(X) RJ-45 Pin Assignments :

Pin Number	Assignment
1	TD+
2	TD-
3	RD+
4	Not used
5	Not used
6	RD-
7	Not used
8	Not used

The device also supports auto MDI/MDI-X operation. You can use a cable to connect the device to a PC. The table below shows the 10/100Base-T(X) MDI and MDI-X port pin outs.

10/100 Base-T(X) MDI/MDI-X Pin Assignments:

Pin Number	MDI port	MDI-X port
1	TD+(transmit)	RD+(receive)
2	TD-(transmit)	RD-(receive)



3	RD+(receive)	TD+(transmit)
4	Not used	Not used
5	Not used	Not used
6	RD-(receive)	TD-(transmit)
7	Not used	Not used
8	Not used	Not used

**Note:** “+” and “-” signs represent the polarity of the wires that make up each wire pair.

### DB9 console port wiring

The serial ports can be connected using a DB9 cable. The DB9 connector supports RS232 / RS422 / RS485 operation modes. Please refer to the following table for the pin assignments of the DB9 connector.

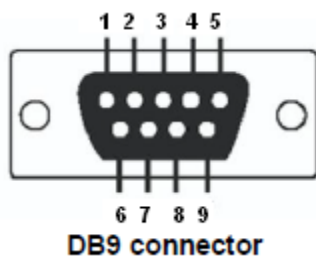

Pin #	RS 232	RS 422	RS 485 ( 4 wire )	RS 485 ( 2 wire )
1	DCD	RXD -	RXD -	
2	RXD	RXD +	RXD +	
3	TXD	TXD +	TXD +	DATA +
4	DTR	TXD -	TXD -	DATA -
5	GND	GND	GND	GND
6	DSR			
7	RTS			
8	CTS			
9	RI			
RS 232 mod act as DTE				

# Management

## 4.1 DS-Tool

The Windows utility DS-Tool is a powerful Windows utility for DS series. It supports device discovery, device configuration, group setup, group firmware update, and monitoring functions. The tool enables you to easily install and configure devices on the network.

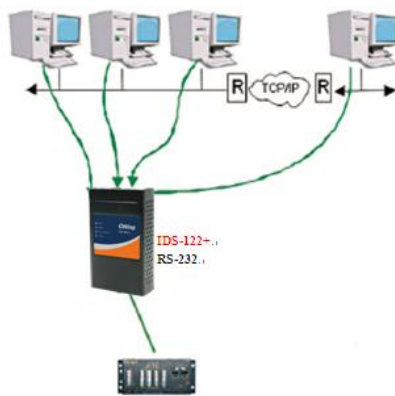

**Multiple Host PCs**

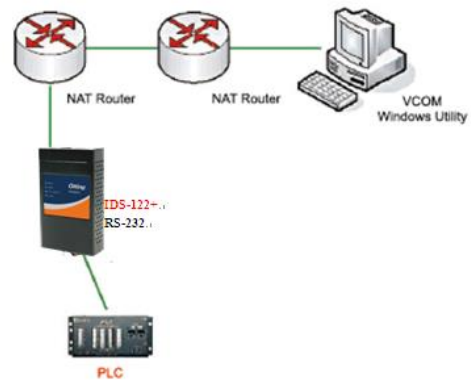

**NAT Router Pass Through**

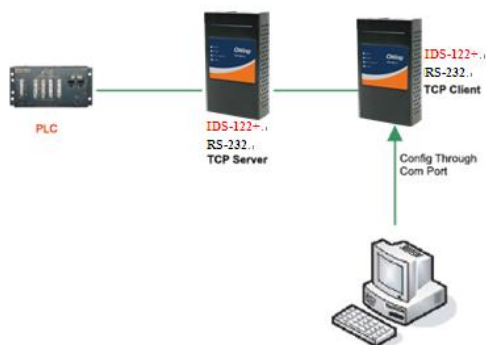

### 4.1.1 Install DS-Tool

Follow the steps below to install the tool.

Step 1: Run the Setup program by clicking **Start** after selecting the folder for DS-Tool.

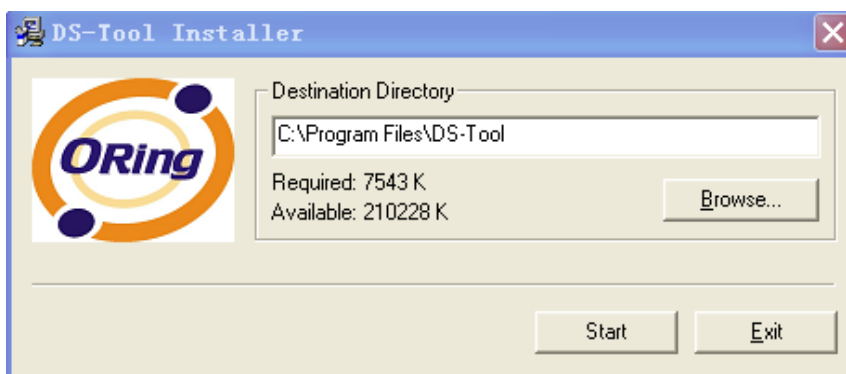

Step 2: When installation completes successfully, click **OK**.

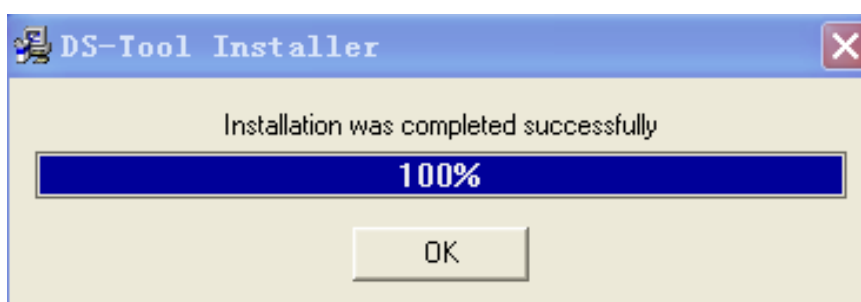

Step 3: You can launch the tool right immediately by checking **Launch DS-Tool Now** or launch it later by checking **Launch DS-Tool Later**.



#### 4.1.2 Using DS-Tool Explore device servers

DS-Tool will broadcast to the network and search all available DS devices in the network automatically. The default IP address of the device is "**192.168.10.2**". Select the device you wish to use and press **Add** button.

You can set a static IP address or use the DHCP client mode to acquire an IP address automatically. Click **OK** and the device will be added.

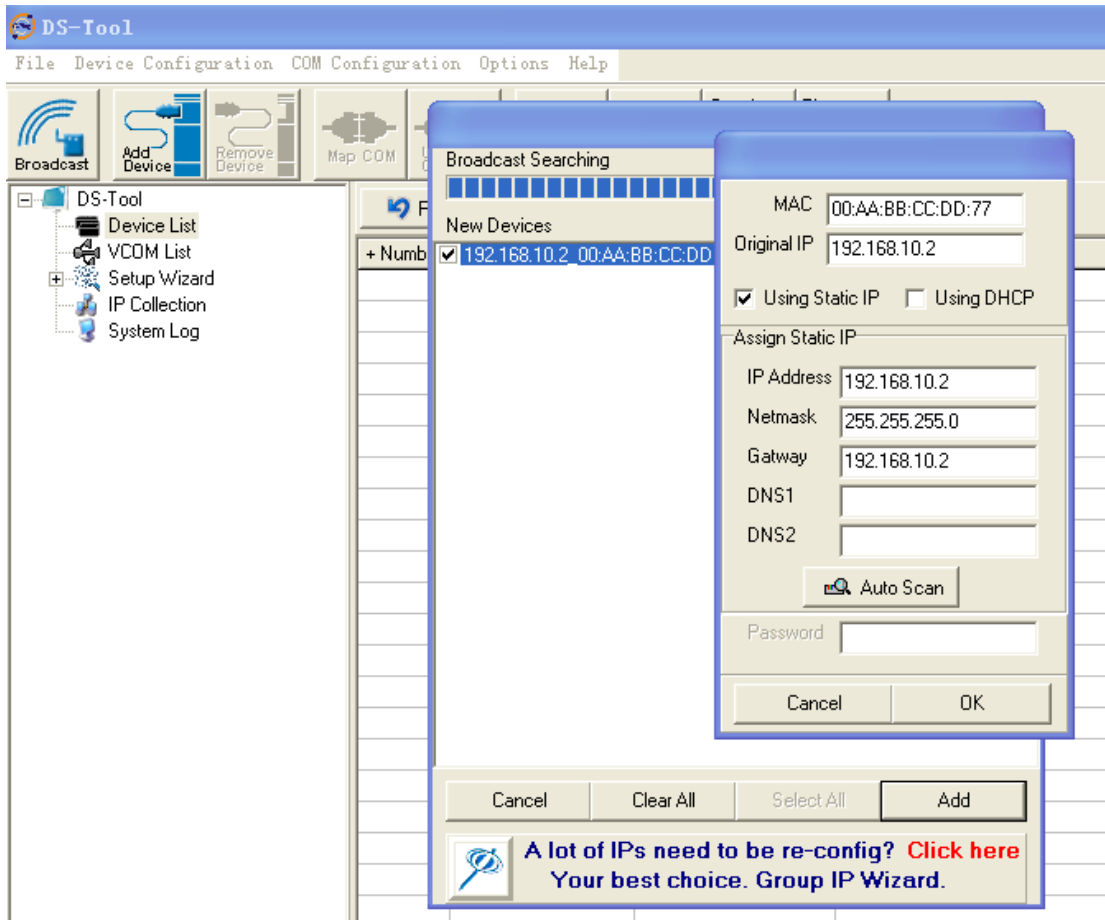

### 4.1.3 Configure Device Servers

#### General

This page enables you to perform general configuration for the device, includes the device name, SNTP server, and auto IP report.

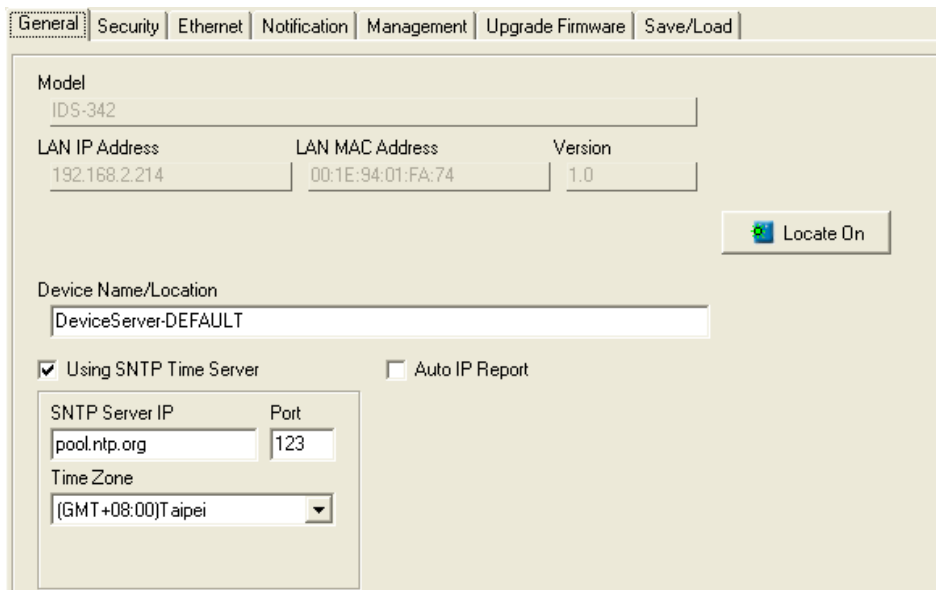

Label	Description
<b>Device Name/Location</b>	You can input the device name or related information in this field. By clicking <b>Locate On</b> , you can locate the serial server's position.
<b>Using SNTP Time Server</b>	If you want to set the time via a SNTP time server, check the box and input related information such as the SNTP server domain name or IP address and the port number, and select a time zone.
<b>Auto IP Report</b>	Check the <b>Auto IP Report</b> box if you want to receive IP report regularly. By Clicking the <b>Get Current Host</b> , you will get your local IP address. Input a value in the Report Interval time based on how often you want the device server to report its status.

## Security

This page allows you to set up access IP tables for your device to allow authorized and deny unauthorized access, thereby ensuring data security and facilitating device management.

Label	Description
<b>Access IP Table</b>	You can input the host IP addresses and network masks to prevent unauthorized access.
<b>Password</b>	You can set the password to prevent unauthorized access from your server. Factory default is no password.

## Ethernet

You must assign a valid IP address for DS before attached in your network environment. Your network administrator should provide you the IP address and related settings. The IP address

must be unique within the network (otherwise, DS will not have a valid connection to the network). You can choose from three possible “IP configuration” modes: Static, DHCP/BOOTP. The Factory Default IP address is “192.168.10.2”

The screenshot shows the 'Wire' configuration page. At the top, there are tabs for 'General', 'Security', 'Ethernet', 'Notification', 'Management', 'Upgrade Firmware', and 'Save/Load'. The 'Wire' tab is active. Below the tabs, there are two radio buttons: 'Using Static IP' (checked) and 'Using DHCP/BOOTP' (unchecked). Underneath, the 'Static IP Settings' section is expanded, showing input fields for 'IP Address' (192.168.2.214), 'Netmask' (255.255.255.0), 'Gateway' (192.168.2.214), 'DNS1', and 'DNS2'.

Label	Description
<b>Using Static IP</b>	Manually assign an IP address to the device.
<b>Using DHCP/BOOTP</b>	Check this box to have the IP address automatically assigned by a DHCP server in your network.
<b>Netmask</b>	All devices on the network must have the same subnet mask to communicate on the network.
<b>Gateway</b>	Enter the IP address of the router in you network.
<b>DNS1/2</b>	Enter the IP addresses of the primary and secondary DNS servers, The DNS server translates domain names into IP address.

**Notification**

Specify the events that should be notified to the administrator. The events can be alarmed by E-mail, SNMP trap, or Syslog.

The screenshot shows the 'Notification' configuration page. At the top, there are tabs for 'General', 'Security', 'Ethernet', 'Notification', 'Management', 'Upgrade Firmware', and 'Save/Load'. The 'Notification' tab is active. Below the tabs, there are three checkboxes: 'SNMP Trap' (unchecked), 'Email Notification' (unchecked), and 'Syslog Notification' (unchecked).

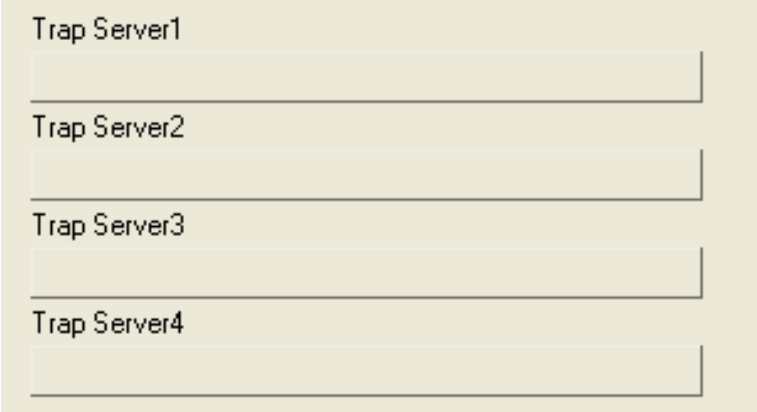
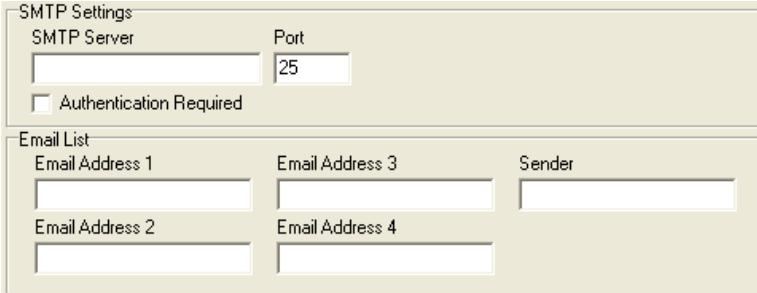
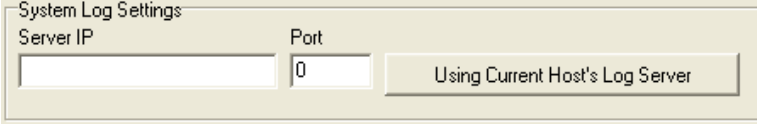
Label	Description
<p><b>SNMP Trap</b></p>	<p>Check the box to allow the system to send SNMP traps when an event occurs. SNMP traps are data packages sent from the SNMP client to the server without being explicitly requested. You need to set up trap servers that will receive these messages if the box is checked.</p> 
<p><b>Email Notification</b></p>	<p>Check the box to allow the system to send e-mails when an event occurs. You need to specify the SMTP Server and the email address to use for sending emails if the box is checked.</p> 
<p><b>Syslog Notification</b></p>	<p>Check the box to allow the system to send a detailed log to an external Syslog server when an event occurs. The syslog will capture all log activity and includes every connection source and destination IP address, IP service, and number of bytes transferred to facilitate troubleshooting. You need to enter Server IP address and Server Port of the syslog server.</p> 
<p><b>Notified items</b></p>	<p>Select the corresponding check box to send an event alert to a remote syslog sever</p>

	<ul style="list-style-type: none"> <li>· Hardware Reset (Cold Start): Rebooting the device from power plug will trigger the event</li> <li>· Software Reset (Warm Start): Rebooting the device from <b>Reboot Device</b> function from <b>Save/Load</b> menu will trigger the event.</li> <li>· Login Failed: Using wrong password in console will trigger the event</li> <li>· IP Changed: Changing network setting will trigger the event</li> <li>· Password Changed: Changing the password will trigger the event.</li> <li>· Access IP Blocked: Report blocked IP addresses</li> </ul>
<p><b>System Log Settings</b></p>	<p>You can specify the server IP address and port or click <b>Using Current Host's Log Server</b> to specify current host as the log server.</p>

## Management

This section enables you to perform management functions using different interfaces including the Web, Telnet, and SNMP.

General
Security
Ethernet
Notification
Management
Upgrade Firmware
Save/Load

Web Management Enable Goto Web Management

Telnet Management Enable Goto Telnet Management

SNMP Management Enable

SNMP Management Settings

Community

Location

Contact

Trap Server1

Trap Server2

Trap Server3

Trap Server4



Label	Description
<b>Web Management Enable</b>	Check the box to enable management from Web. Click <b>Goto Web Management</b> button to access the Web.
<b>Telnet Management Enable</b>	Check the box to enable management by Telnet. Click <b>Goto Telnet Management</b> button to execute Telnet command.
<b>SNMP Management Enable</b>	Check the box to enable management by SNMP.
<b>SNMP Management Settings</b>	If <b>SNMP Management Enable</b> is checked, you need to fill in the SNMP settings in these fields by assigning the <b>Community, Location, Contact, and Trap Server</b> .

### Upgrade Firmware

You can find up-to-date firmware from ORing’s website. To update firmware for the device, save the firmware file in your host PC, and then specify the file location by clicking on the **Browsing** button and continue operation by pressing **Update**.

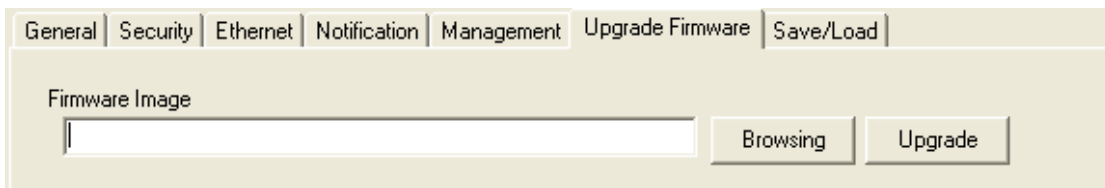

### Save/Load

This page allows you to save the current configuration file to any local drive or any network drive to which your management computer can connect.

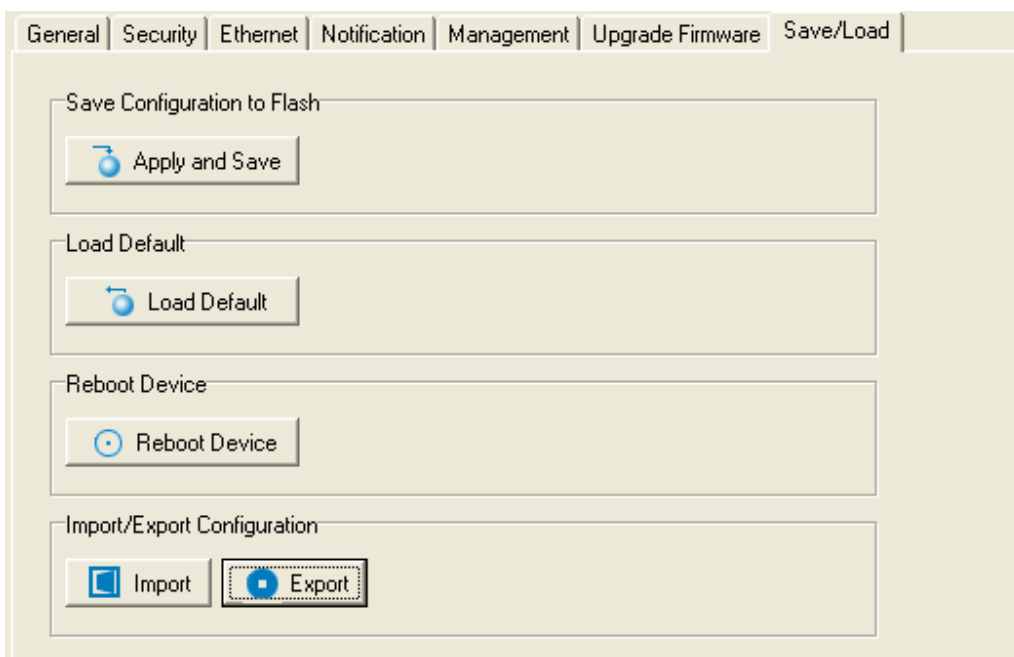

Label	Description
<b>Apply and Save</b>	Click this button will save all applied settings into the flash of the appliance
<b>Load Default</b>	All parameters changes to factory's default except network settings. If you want to load all factory default, you need to press <b>Reset</b> button on the device (Hardware restore).
<b>Reboot Device</b>	Click this button will reboot device and need to broadcast again in order to search the device (warm start).
<b>Import Configuration</b>	Click this button will retrieve saved configuration file and apply it to in current device
<b>Export Configuration</b>	Saving the current parameters to a file and export it to a current host.

#### 4.1.4 Configure Serial Port

You can configure the settings for each serial port by clicking on the port number in the left panel of the window. Once you click on a port, the following screen will show up in the right panel.

### Serial Settings

The page allows you to configure serial parameters, serial communication modes, data packing options, and event notifications.

Serial Settings | Service Mode | Notification

port1

Port Alias

Baudrate  Stop Bits  Performance

Parity  Flow Control

Data Bits  Interface

Delimiter Settings

Serial to Ethernet | Ethernet to Serial

Delimiter 1  (HEX)  Enabled

Delimiter 2  (HEX)  Enabled

Delimiter 3  (HEX)  Enabled

Delimiter 4  (HEX)  Enabled

Flush Ethernet to Serial Data Buffer After  (0-65535) ms

The received data will be queueing in the buffer until all the delimiters are matched. When the buffer is full (4K Bytes) or after "flush E2S data buffer" timeout, the data will also be sent.

Force TX interval time  (0-65535) ms  interval time  interval time

The received data will be queueing in TX buffer until TX interval time is timeout or TX buffer is full (4K Bytes) , the data will also be sent. 0 is disable.

Label	Description
<b>Port Alias</b>	Port alias enables the device server to easily identify the serial devices connected to it. Enter an identifying name to be identified by the connected device.
<b>Baud rate</b>	Baud rate is the rate at which data is transferred over a serial link. When setting the baud rate to 9600bps, the serial port will transfer a maximum of 9600 bits per second. You can select a baud rate from the drop-down list which ranges from 110bps to 460800bps
<b>Parity</b>	Parity is a simple form of error detection which guards data on the cable between the connected devices and the serial port. Available options include:  <b>None:</b> parity checking is not performed and the parity bit is not transmitted.  <b>Odd:</b> the number of mark bits in the data is counted, and the parity bit is asserted or unasserted to obtain an odd number

	<p>of mark bits.</p> <p><b>Even:</b> the number of mark bits in the data is counted, and the parity bit is asserted or unasserted to obtain an even number of mark bits.</p> <p><b>Mark:</b> the parity bit is always set to the mark signal condition (logical 1)</p> <p><b>Space:</b> the last transmitted data bit will always be a logical 0</p>
<p><b>Data Bits</b></p>	<p>Choose the number of data bits to transmit. You can configure data bits to be 5, 6, 7, or 8. Data is transmitted as a series of five, six, seven, or eight bits (five and six bit data formats are used rarely for specialized communications equipment).</p>
<p><b>Stop Bits</b></p>	<p>Choose the number of bits used to indicate the end of a byte. You can configure stop bits to be 1 or 2(1.5). If Stop Bits is 1.5, the stop bit is transferred for 150% of the normal time used to transfer one bit. Both the computer and the peripheral device must be configured to transmit the same number of stop bits.</p>
<p><b>Flow Control</b></p>	<p>Serial communication consists of hardware flow control and software flow control, so called as the control is handled by software or hardware. <b>XOFF</b> and <b>OXN</b> is software flow control while <b>RTS/CTS</b> or <b>DTR/DSR</b> is hardware flow control.</p> <p>Choose <b>XOFF</b> to tell the computer to stop sending data; then the receiving side will send an XOFF character over its Tx line to tell the transmitting side to stop transmitting. Choose <b>XON</b> to tell the computer to begin sending data again; then the receiving side will send an XON character over its Tx line to tell the transmitting side to resume transmitting. In hardware flow control mode, when the device is ready to receive data, it sends a CTS (Clear To Send) signal to the device on the other end. When a device has something it wants to send, it will send a RTS (Ready To Send) signal and waits for a CTS signal to come back its way. These signals are sent apart from the data itself on separate wires.</p>

<b>Interface</b>	Choose an interface for your serial device. Available interfaces include <b>RS-232, RS-422, RS-485(2-wires), and RS-485(4-wires),</b>
<b>Performance</b>	<b>Throughput:</b> guarantees highest transmission speed. <b>Latency:</b> guarantees shortest response time.
<b>Delimiter Settings</b>	<b>Serial to Ethernet / Ethernet to Serial</b> For advanced data packing options, you can specify delimiters for Serial to Ethernet and / or Ethernet to Serial communications. You can define max. 4 delimiters (00~FF, Hex) for each way. The data will be hold until the delimiters are received or the option. <b>Flush Serial to Ethernet data buffer</b> times out. <b>0</b> means disable. Factory default is <b>0</b> . <b>Flush Data Buffer After:</b> The received data will be queuing in the buffer until all the delimiters are matched. When the buffer is full (4K Bytes) or after " <b>flush S2E data buffer</b> " timeout the data will also be sent. You can set the time from 0 to 65535 seconds.
<b>Force TX Interval Time</b>	Force TX interval time is to specify the timeout when no data has been transmitted. When the timeout is reached or TX buffer is full (4K Bytes), the queued data will be sent. <b>0</b> means disable. Factory default value is <b>0</b> .

## Service Mode

### Virtual COM Mode

In Virtual COM Mode, the driver establishes a transparent connection between host and serial device by mapping the port of the serial server serial port to a local COM port on the host computer. Virtual COM Mode also supports up to 5 simultaneous connections, so that multiple hosts can send or receive data by the same serial device at the same time.

Serial Settings
Service Mode
Notification

port1  
 Service Mode Virtual COM Mode ▾

Virtual COM Mode  
 Virtual COM Mode  
 TCP Server Mode  
 TCP Client Mode  
 UDP Mode

Virtual COM Settings  
 Data Port   Edit IP Port Number  
 Control Port

Misc.  
 Idle Timeout  (0-65535) Seconds  
 Alive Check  (0-65535) Seconds

Multilink  
 Max Connections

#	Destination Host	VCOM Name		
1	<input type="text"/>	Waiting for VCOM connect	<input type="button" value="Goto VCom"/>	<input type="button" value="Unmap VCom"/>
2	<input type="text"/>	<input type="text"/>	<input type="button" value="Goto VCom"/>	<input type="button" value="Unmap VCom"/>
3	<input type="text"/>	<input type="text"/>	<input type="button" value="Goto VCom"/>	<input type="button" value="Unmap VCom"/>
4	<input type="text"/>	<input type="text"/>	<input type="button" value="Goto VCom"/>	<input type="button" value="Unmap VCom"/>
5	<input type="text"/>	<input type="text"/>	<input type="button" value="Goto VCom"/>	<input type="button" value="Unmap VCom"/>

Label	Description
<b>Data Port</b>	Set the port number for data transmission.
<b>Idle Timeout</b>	When a serial port stops data transmission for a defined period of time (Idle Timeout), the connection will be closed and the port will be freed and try to connect with other hosts. <b>0</b> means the function is disabled which is also the factory default value. If multilink is configured, only the first host connection is effective for this setting.
<b>Alive Check</b>	The serial device will send a TCP alive-check package in each defined time interval (Alive Check) to remote host to check the the status of TCP connections. If the TCP connection is not alive, the connection will be closed and the port will be freed. <b>0</b> means the function is disabled which is also the factory default value.
<b>Max Connection</b>	The number of max connections can be supported simultaneously is <b>5</b> ; default values is <b>1</b> .
<b>Map Virtual COM</b>	Select a Virtual COM name to map on.

## TCP Server Mode

In TCP Server mode, the serial port on the device server is assigned a unique port number. The host computer initiates contact with the device server, establishes the connection, and receives data from the serial device. Five simultaneous connections are supported in this mode, enabling multiple hosts to collect data from the same serial device at the same time.

Label	Description
<b>Data Port</b>	Set the port number for data transmission.
<b>Auto Scan</b>	Scan the data port automatically.
<b>Idle Timeout</b>	When a serial port stops data transmission for a defined period of time (Idle Timeout), the connection will be closed and the port will be freed and try to connect with other hosts. <b>0</b> means the function is disabled which is the factory default value. If multilink is configured, only the first host connection is effective for this setting.
<b>Alive Check</b>	The serial device will send a TCP alive-check package in each defined time interval (Alive Check) to remote host to check the TCP connection. If the TCP connection is not alive, the connection will be closed and the port will be freed. <b>0</b> means the

	function is disabled which is the factory default value.
<b>Max Connection</b>	The number of maximum connections can be support simultaneously is <b>5</b> ; default values is <b>1</b> .
<b>Destination Host</b>	Input the IP address of the host.

### TCP Client Mode

In TCP Client mode, the device can establish a TCP connection with the server by the method you have settled (Startup or any character). After the data has been transferred, the device can disconnect automatically from the server by using the TCP alive check time or idle time settings.

Label	Description
<b>Destination Host</b>	Input the IP address of the host.
<b>Port</b>	Set the port number of data port.
<b>Idle Timeout</b>	When a serial port stops data transmission for a defined period of time (Idle Timeout), the connection will be closed and the port will be freed and try to connect with other hosts. <b>0</b> means the function is disabled which is the factory default value. If multilink is configured, only the first host connection is effective for this setting.
<b>Alive Check</b>	The serial device will send a TCP alive-check package in each



	defined time interval (Alive Check) to remote host to check the TCP connection. If the TCP connection is not alive, the connection will be closed and the port will be freed. <b>0</b> means the function is disabled which is the factory default value.
<b>Connect on Startup</b>	The TCP Client will build a TCP connection once the connected serial device is started.
<b>Connect on Any Character</b>	The TCP Client will build a TCP connection once the connected serial device starts to send data.

### UDP Mode

Compared to TCP communication, UDP is faster and more efficient as you can unicast or multicast data from the serial device server to host computers, and the serial device can also receive data from one or multiple host.

Label	Description
<b>Listening Port</b>	IP port for listening incoming messages
<b>Destination Host Begin / End</b>	If there are more than one destination hosts, specify the IP address range by inputting a value in destination host IP begin / end fields. You can also auto scan the sending port number of the device
<b>Sending Port</b>	IP port for sending outgoing messages

## Notification

Port status can be notified to administrator by means of Email, SNMP trap, or System Log. You can specify the events that should be noticed and the notification methods in this page.

Label	Description
<b>DCD changed</b>	When DCD (Data Carrier Detect) signal changes, it indicates that the modem connection status has changed. A notification will be sent if the box is checked.
<b>DSR changed</b>	When DSR (Data Set Ready) signal changes, it indicates that the data communication equipment is powered off. A notification will be sent if the box is checked.
<b>RI changed</b>	When RI (Ring Indicator) signal changes, it indicates that the incoming of a call. A notification will be sent if the box is checked.
<b>CTS changed</b>	When CTS (Clear To Send) signal changes, it indicates that the transmission between computer and DCE can proceed. A notification will be sent if the box is checked.

<b>Port connected</b>	In TCP Server Mode, when the device accepts an incoming TCP connection, this event will be triggered. In TCP Client Mode, when the device has connected to the remote host, this event will be triggered. In Virtual COM Mode, Virtual COM is ready to use. A notification will be sent if the box is checked.
<b>Port disconnected</b>	In TCP Server/Client Mode, when the device loses the TCP link, this event will be triggered. In Virtual COM Mode, when Virtual COM is not available, this event will be triggered. A notification will be sent if the box is checked.

## 4.2 Web Management

The device can be managed via a built-in web server which supports Internet Explorer (Internet Explorer 5.0 or above versions) and other Web browsers such as Chrome. Therefore, you can manage and configure the device easily and remotely. You can also upgrade firmware via a Web browser. The Web management function not only reduces network bandwidth consumption, but also enhances access speed and provides a user-friendly viewing screen.

**Note:** By default, IE5.0 or later version do not allow Java applets to open sockets. You need to modify the browser setting separately in order to enable Java applets for network ports.

### Management via Web Browser

Follow the steps below to manage your device via a Web browser

#### System Login

1. Launch an Internet Explorer.
2. Type http:// and the IP address of the device. Press **Enter**.



3. A login screen appears.
4. Type in the username **admin**. By default, no password is required; however, you can set up a password later in the management page.
5. Press **Enter** or click **OK**, the management page appears.



Note: you can use the following default values:

IP Address: **192.168.10.1**

Subnet Mask: **255.255.255.0**

Default Gateway: **192.168.10.254**

User Name: **admin**

Password: **admin**

After logging in, you will see the information of the device as below.

<b>System Information</b>	
<b>IP Address</b>	192.168.2.203
<b>MAC Address</b>	44:44:44:44:44:44

On the left hand side of the management interface shows links to various settings. Clicking on the links will bring you to individual configuration pages.

## 4.2.1 System

### 4.2.1.1 Time (SNTP)

SNTP (Simple Network Time Protocol) is a protocol able to synchronize the time on your system to the clock on the Internet. It will synchronize your computer system time with a server that has already been synchronized by a source such as a radio, satellite receiver or modem.

**SNTP Configuration**

<b>Name</b>	DeviceServer-DEFAULT	
<b>Time</b>		
<b>SNTP</b>	<input checked="" type="radio"/> Enable <input type="radio"/> Disable	
<b>Time Zone</b>	(GMT+08:00)Taipei	
<b>Local Time</b>	Thu May 21 2015 13:53:10 GMT	
<b>Time Server</b>	pool.ntp.org	Port 123
<b>Console</b>		
<b>Telnet Console</b>	<input checked="" type="radio"/> Enable <input type="radio"/> Disable	
<input type="button" value="Apply"/>		

Label	Description
<b>Name</b>	Enter the model name of the device
<b>SNTP</b>	Enable or disable SNTP function
<b>Time Zone</b>	Choose the time zone according to the location of the device
<b>Local Time</b>	Set up the local time
<b>Time Server</b>	Enter the address of the time server
<b>Telnet Console</b>	Click to enable or disable Telnet console function.

The following table lists different location time zones for your reference.

Local Time Zone	Conversion from UTC	Time at 12:00 UTC
November Time Zone	- 1 hour	11 am
Oscar Time Zone	-2 hours	10 am
ADT - Atlantic Daylight	-3 hours	9 am
AST - Atlantic Standard EDT - Eastern Daylight	-4 hours	8 am
EST - Eastern Standard CDT - Central Daylight	-5 hours	7 am
CST - Central Standard MDT - Mountain Daylight	-6 hours	6 am
MST - Mountain Standard PDT - Pacific Daylight	-7 hours	5 am
PST - Pacific Standard ADT - Alaskan Daylight	-8 hours	4 am
ALA - Alaskan Standard	-9 hours	3 am
HAW - Hawaiian Standard	-10 hours	2 am
Nome, Alaska	-11 hours	1 am
CET - Central European FWT - French	+1 hour	1 pm

Winter MET - Middle European MEWT - Middle European Winter SWT - Swedish Winter		
EET - Eastern European, USSR Zone 1	+2 hours	2 pm
BT - Baghdad, USSR Zone 2	+3 hours	3 pm
ZP4 - USSR Zone 3	+4 hours	4 pm
ZP5 - USSR Zone 4	+5 hours	5 pm
ZP6 - USSR Zone 5	+6 hours	6 pm
WAST - West Australian Standard	+7 hours	7 pm
CCT - China Coast, USSR Zone 7	+8 hours	8 pm
JST - Japan Standard, USSR Zone 8	+9 hours	9 pm
EAST - East Australian	+10 hours	10 pm
Standard GST Guam Standard, USSR Zone 9		
IDLE - International Date Line NZST - New Zealand Standard NZT - New Zealand	+12 hours	Midnight

#### 4.2.1.2 IP Configuration

This page allows you to configure IP settings for the device. You can assign an IP address manually or leave it to DHCP/BOOTP servers which will reply with an automatically generated IP address and subnet mask for the device when they receive the request. The IP address must be unique and within the network, otherwise the device will not have a valid connection to the network. Select **Static IP** if you are using a fixed IP address. Click **Apply** after you complete configuration.

### IP Configuration

IP Configuration	Static
IP Address	DHCP/BOOTP
Netmask	255.255.255.0
Gateway	192.168.10.1
DNS Server 1	192.168.10.1
DNS Server 2	
Auto IP Report	
Auto Report to IP	
Auto Report to TCP Port	0
Auto Report Interval	0 seconds

Label	Description
<b>IP Configuration</b>	Choose to use a static or DHCP-assigned IP. If you choose DHCP, the following fields will gray out. <b>Static:</b> Input an IP address for the device. <b>DHCP/BOOTP:</b> allows the IP address of the device to be automatically assigned by a configuration server.
<b>IP Address</b>	Enter the IP address that identifies the server on the TCP/IP network
<b>Netmask</b>	Enter a subnet mask for the device.
<b>Gateway</b>	Enter the IP address of the router that provides network access outside the server's LAN
<b>DNS Server 1/2</b>	Enter the IP address of the primary and secondary domain name server
<b>Auto Report to IP</b>	Specify an IP address for reports generated by the Auto report function to be automatically sent to.
<b>Auto Report to TCP Port</b>	Specify a TCP Port for reports generated by the Auto report function to be automatically sent to.

<b>Auto Report Interval</b>	Specify a time interval for which reports will be delivered.
-----------------------------	--

### 4.2.1.3 User Authentication

This page allows you to set up login account and password. You can also change your password in this page.

**User Authentication**

<b>Old Password</b>	<input type="text"/>
<b>New Password</b>	<input type="text"/>
<b>Confirm New Password</b>	<input type="text"/>

Label	Description
<b>Old Password</b>	Enter the existing password that is used to log in
<b>New Password</b>	Enter a new password that will be used to log in
<b>Confirm New Password</b>	Retype the new password to confirm

## 4.2.2 Port Serial Setting

### 4.2.2.1 Serial Configuration

This page allows you to configure serial port parameters.



### Serial Configuration

	Port1 ▼
Port Alias	Port1
Interface	RS485(4-wires) ▼
Baud Rate	38400 ▼
Data Bits	8 ▼
Stop Bits	1 ▼
Parity	None ▼
Flow Control	None ▼
Force TX Interval Time	0 ms
Performance	<input checked="" type="radio"/> Throughput <input type="radio"/> Latency

Label	Description
<b>Port Alias</b>	Enter the COM port number that modem is connected to
<b>Interface</b>	Choose an interface for your serial device. Available interfaces include <b>RS-232, RS-422, RS-485(2-wires), and RS-485(4-wires),</b>
<b>Baud Rate</b>	Choose a baud rate in the range between 110 bps and 460800 bps.
<b>Data Bits</b>	Choose the number of data bits to transmit. You can configure data bits to be 5, 6, 7, or 8. Data is transmitted as a series of five, six, seven, or eight bits (five and six bit data formats are used rarely for specialized communications equipment).
<b>Stop Bits</b>	Choose the number of bits used to indicate the end of a byte. You can configure stop bits to be 1 or 2(1.5). If Stop Bits is 1.5, the stop bit is transferred for 150% of the normal time used to transfer one bit. Both the computer and the peripheral device must be configured to transmit the same number of stop bits.
<b>Parity</b>	Chose the method of detecting errors in transmission. Parity

	<p>control bit modes include None, Odd, Even, Mark, and Space.</p> <p><b>None:</b> parity checking is not performed and the parity bit is not transmitted.</p> <p><b>Odd:</b> the number of mark bits in the data is counted, and the parity bit is asserted or unasserted to obtain an odd number of mark bits.</p> <p><b>Even:</b> the number of mark bits in the data is counted, and the parity bit is asserted or unasserted to obtain an even number of mark bits.</p> <p><b>Mark:</b> the parity bit is always set to the mark signal condition (logical 1)</p> <p><b>Space:</b> the last transmitted data bit will always be a logical 0</p>
<p><b>Flow Control</b></p>	<p>Serial communication consists of hardware flow control and software flow control, so called as the control is handled by software or hardware. <b>XOFF</b> and <b>XON</b> is software flow control while <b>RTS/CTS</b> or <b>DTR/DSR</b> is hardware flow control.</p> <p>Choose <b>XOFF</b> to tell the computer to stop sending data; then the receiving side will send an XOFF character over its Tx line to tell the transmitting side to stop transmitting. Choose <b>XON</b> to tell the computer to begin sending data again; then the receiving side will send an XON character over its Tx line to tell the transmitting side to resume transmitting. In hardware flow control mode, when the device is ready to receive data, it sends a CTS (Clear To Send) signal to the device on the other end. When a device has something it wants to send, it will send a RTS (Ready To Send) signal and waits for a CTS signal to come back its way. These signals are sent apart from the data itself on separate wires.</p>
<p><b>FaceTX Interval Time</b></p>	<p>Force TX interval time is to specify the timeout when no data has been transmitted. When the timeout is reached or TX buffer is full (4K Bytes), the queued data will be sent. <b>0</b> means disable. Factory default value is <b>0</b>.</p>
<p><b>Performance</b></p>	<p><b>Throughput:</b> This mode optimized for highest transmission speed.</p> <p><b>Latency:</b> This mode optimized for shortest response time.</p>

### 4.2.2.2 Port Profile

**Port Profile**

	Port1 ▾
Local TCP Port	4016
Mode	Serial to Ethernet
Flush Data Buffer After	0 ms
Delimiter(Hex 0~ff)	1: 00 2: 00 3: 00 4: 00
Mode	Ethernet to Serial
Flush Data Buffer After	0 ms
Delimiter(Hex 0~ff)	1: 00 2: 00 3: 00 4: 00

Label	Description
<b>Local TCP Port</b>	The TCP port the device uses to listen to connections, and that other devices must use to contact the device. To avoid conflicts with well known TCP ports, the default is set to 4000.
<b>Flush Data Buffer After</b>	The received data will be queuing in the buffer until all the delimiters are matched. When the buffer is full (4K Bytes) or after " <b>flush S2E data buffer</b> " timeout the data will also be sent. You can set the time from 0 to 65535 seconds.
<b>Delimiter</b>	For advanced data packing options, you can specify delimiters for <b>Serial to Ethernet</b> and / or <b>Ethernet to Serial</b> communications. You can define max. 4 delimiters (00~FF, Hex) for each way. The data will be hold until the delimiters are received or the option <b>Flush Serial to Ethernet data buffer</b> times out. <b>0</b> means disable. Factory default is <b>0</b> .

### 4.2.2.3 Service Mode

#### Virtual COM Mode

In Virtual COM Mode, the driver establishes a transparent connection between the host and the serial device by mapping the port of the serial server to a local COM port on the host computer. Virtual COM Mode also supports up to 5 simultaneous connections, so that multiple hosts can send or receive data by the same serial device at the same time.

**Service Mode**

	Port1 ▾
Data Encryption	<input type="radio"/> Enable <input checked="" type="radio"/> Disable
Service Mode	Virtual COM Mode ▾
Idle Timeout	0 (0~65535)seconds
Alive Check	40 (0~65535)seconds
Max Connection	1 ▾ max. connection (1~5)

Label	Description
<b>Data Encryption</b>	Click on the radio button to enable or disable data encryption
<b>Idle Timeout</b>	When serial port stops data transmission for a defined period of time, the connection will be closed and the port will be freed and try to connect with other hosts. 0 indicate disable this function. Factory default value is 0. If Multilink is configured, only the first host connection is effective for this setting.
<b>Alive Check</b>	The serial device will send TCP alive-check packages in each defined time interval to remote host to check the TCP connection. If the TCP connection is not alive, the connection will be closed and the port will be freed. 0 indicate disable this function. Factory default is 0.
<b>Max Connection</b>	The number of Max connection can support simultaneous connections are 5, default values is 1.

*\*Not allowed to mapping Virtual COM from web*

**TCP Server Mode**

In TCP Server Mode, DS is configured with a unique port combination on a TCP/IP network. In this case, DS waits passively to be contacted by the device. After the device establishes a connection with the serial device, it can then proceed with data transmission. TCP Server mode also supports up to 5 simultaneous connections, so that multiple device can receive data from the same serial device at the same time.

### Service Mode

	Port1 ▾
Data Encryption	<input type="radio"/> Enable <input checked="" type="radio"/> Disable
Service Mode	TCP Server Mode ▾
Telnet Negotiation	<input type="radio"/> Enable <input checked="" type="radio"/> Disable
TCP Server Port	4016
Idle Timeout	0 (0~65535)seconds
Alive Check	40 (0~65535)seconds
Max Connection	1 ▾ max. connection(1~5)

Label	Description
<b>Data Encryption</b>	Click on the radio button to enable or disable data encryption
<b>TCP Server Port</b>	Enter the TCP server port number
<b>Idle Timeout</b>	When serial port stops data transmission for a defined period of time, the connection will be closed and the port will be freed and try to connect with other hosts. 0 indicate disable this function. Factory default value is 0. If Multilink is configured, only the first host connection is effective for this setting.
<b>Alive Check</b>	The serial device will send TCP alive-check package in each defined time interval (Alive Check) to remote host to check the TCP connection. If the TCP connection is not alive, the connection will be closed and the port will be freed. 0 indicate disable this function. Factory default is 0.
<b>Max Connection</b>	The serial device will send TCP alive-check packages in each defined time interval to remote host to check the TCP connection. If the TCP connection is not alive, the connection will be closed and the port will be freed. 0 indicate disable this function. Factory default is 0.

### TCP Client Mode

In TCP Client Mode, the device can establish a TCP connection with the server by the method you set (Startup or any character). After the data has been transferred, the device can disconnect automatically from the server by using the TCP alive check time or idle timeout settings.

### Service Mode

	Port1 ▾
Data Encryption	<input type="radio"/> Enable <input checked="" type="radio"/> Disable
Service Mode	TCP Client Mode ▾
Destination Host	<input type="text"/> : <input type="text" value="4016"/>
Idle Timeout	<input type="text" value="0"/> (0~65535)seconds
Alive Check	<input type="text" value="40"/> (0~65535)seconds
Connect on	<input checked="" type="radio"/> Startup <input type="radio"/> Any Character
Destination Host	Port
1.	<input type="text"/> <input type="text" value="65535"/>
2.	<input type="text"/> <input type="text" value="65535"/>
3.	<input type="text"/> <input type="text" value="65535"/>
4.	<input type="text"/> <input type="text" value="65535"/>

Label	Description
<b>Data Encryption</b>	Click on the radio button to enable or disable data encryption
<b>Destination Host</b>	Set the IP address of host and the port number of data port. .
<b>Idle Timeout</b>	When serial port stops data transmission for a defined period of time, the connection will be closed and the port will be freed and try to connect with other hosts. 0 indicate disable this function. Factory default value is <b>0</b> . If Multilink is configured, only the first host connection is effective for this setting.
<b>Alive Check</b>	The serial device will send TCP alive-check packages in each defined time interval to remote host to check the TCP connection. If the TCP connection is not alive, the connection will be closed and the port will be freed. <b>0</b> indicate disable this function. Factory default is <b>0</b> .
<b>Connect on Startup</b>	The TCP Client will build TCP connection once the connected serial device is started.
<b>Connect on Any Character</b>	The TCP Client will build TCP connection once the connected serial device starts to send data.

### UDP Mode

Compared to TCP communications, UDP is faster and more efficient. In UDP mode, you can

uni-cast or multi-cast data from the serial device server to host computers, and the serial device can also receive data from one or multiple host.

**Service Mode**

	Port1 ▾	
<b>Service Mode</b>	UDP Mode ▾	
<b>Listen Port</b>	4016	
<b>Host start IP</b>	<b>Host end IP</b>	<b>Send Port</b>
1.	<input type="text"/>	<input type="text" value="65535"/>
2.	<input type="text"/>	<input type="text" value="65535"/>
3.	<input type="text"/>	<input type="text" value="65535"/>
4.	<input type="text"/>	<input type="text" value="65535"/>

Label	Description
<b>Listen Port</b>	Allows the user to set a new TCP port number to listen on rather than the default value of the device
<b>Host Start/End IP</b>	If there are more than one destination hosts, specify the IP address range by inputting a value in <b>Host Start / End IP</b> . You can also auto scan the sending port number of the device
<b>Send Port</b>	Set the send port number.

**4.2.3 Management**

**4.2.3.1 Access IP Control**

Access IP Control List allows you to add or block remote host IP addresses to prevent unauthorized access. If a host's IP address is in the accessible IP table, the host will be allowed to access the DS. You can check

**Access IP Control List**

<input type="checkbox"/> Enable IP Filtering (Not check this option will allow any IP to have assessibility)			
No.	Activate the IP	IP Address	Netmask
1	<input type="checkbox"/>	<input type="text"/>	<input type="text"/>
2	<input type="checkbox"/>	<input type="text"/>	<input type="text"/>
3	<input type="checkbox"/>	<input type="text"/>	<input type="text"/>
4	<input type="checkbox"/>	<input type="text"/>	<input type="text"/>
5	<input type="checkbox"/>	<input type="text"/>	<input type="text"/>
6	<input type="checkbox"/>	<input type="text"/>	<input type="text"/>
7	<input type="checkbox"/>	<input type="text"/>	<input type="text"/>
8	<input type="checkbox"/>	<input type="text"/>	<input type="text"/>

Label	Description
<b>Enable IP Filtering</b>	Leaving the box unchecked means any host can access the device server.
<b>Activate the IP</b>	Check the box to activate the IP address
<b>IP Address</b>	Only the host with the specified IP address can access the device server. The format should be IP address /255.255.255.255 (e.g., "192.168.0.1/255.255.255.255").
<b>Netmask</b>	Only the host on the specified subnet can access the device server. The format should be IP address /255.255.255.0 (e.g., "192.168.0.1/255.255.255.0").

**4.2.3.2 SMTP/SNMP Conf**

Email server configurations include the mail server’s IP address or domain. If authentication is required, you need to specify your username and password. You can set up to four email addresses for receiving notifications.

SNMP server configurations include the SNMP trap server IP address, community, location and contact. You can set up to four SNMP addresses you for receiving notifications.



**SMTP/SNMP Configuration**

<b>E-mail Settings</b>	
<b>SMTP Server</b>	<input type="text"/> Port <input type="text" value="25"/>
<input type="checkbox"/> My server requires authentication	
<b>User Name</b>	<input type="text"/>
<b>Password</b>	<input type="text"/>
<b>E-mail Sender</b>	<input type="text"/>
<b>E-mail Address 1</b>	<input type="text"/>
<b>E-mail Address 2</b>	<input type="text"/>
<b>E-mail Address 3</b>	<input type="text"/>
<b>E-mail Address 4</b>	<input type="text"/>
<b>SNMP Trap Server</b>	
<b>SNMP Server 1</b>	<input type="text"/>
<b>SNMP Server 2</b>	<input type="text"/>
<b>SNMP Server 3</b>	<input type="text"/>
<b>SNMP Server 4</b>	<input type="text"/>
<b>Community</b>	<input type="text"/>
<b>Location</b>	<input type="text"/>
<b>Contact</b>	<input type="text"/>

<b>Syslog Server</b>	
<b>Syslog Server IP</b>	<input type="text"/>
<b>Syslog Server Port</b>	<input type="text" value="0"/>
<input type="button" value="Apply"/>	

### 4.2.3.3 System Event Conf.

Specify the events that will be reported to the administrator. The notifications of the events can be done via e-mail, SNMP trap, or system log.

## System Event Configuration

Device Event Notification			
Hardware Reset (Cold Start)	<input type="checkbox"/> SMTP Mail	<input type="checkbox"/> SNMP Trap	<input type="checkbox"/> Syslog
Software Reset (Warm Start)	<input type="checkbox"/> SMTP Mail	<input type="checkbox"/> SNMP Trap	<input type="checkbox"/> Syslog
Login Failed	<input type="checkbox"/> SMTP Mail	<input type="checkbox"/> SNMP Trap	<input type="checkbox"/> Syslog
IP Address Changed	<input type="checkbox"/> SMTP Mail	<input type="checkbox"/> SNMP Trap	<input type="checkbox"/> Syslog
Password Changed	<input type="checkbox"/> SMTP Mail	<input type="checkbox"/> SNMP Trap	<input type="checkbox"/> Syslog
Access IP Blocked	<input type="checkbox"/> SMTP Mail	<input type="checkbox"/> SNMP Trap	<input type="checkbox"/> Syslog
Port Event Notification	Port1 ▼		
DCD Changed	<input type="checkbox"/> SMTP Mail	<input type="checkbox"/> SNMP Trap	<input type="checkbox"/> Syslog
DSR Changed	<input type="checkbox"/> SMTP Mail	<input type="checkbox"/> SNMP Trap	<input type="checkbox"/> Syslog
RI Changed	<input type="checkbox"/> SMTP Mail	<input type="checkbox"/> SNMP Trap	<input type="checkbox"/> Syslog
CTS Changed	<input type="checkbox"/> SMTP Mail	<input type="checkbox"/> SNMP Trap	<input type="checkbox"/> Syslog
Port Connected	<input type="checkbox"/> SMTP Mail	<input type="checkbox"/> SNMP Trap	<input type="checkbox"/> Syslog
Port Disconnected	<input type="checkbox"/> SMTP Mail	<input type="checkbox"/> SNMP Trap	<input type="checkbox"/> Syslog

Label	Description
<b>Hardware Reset (Cold Start)</b>	This refers to starting the system from power off (in contrast with warm start). When performing a cold start, DS will automatically issue an auto warning message via e-mail, logs, or SNMP trap after booting.
<b>Software Reset (Warm Start)</b>	This refers to restarting the computer without turning the power off. When performing a warm start, DS will automatically send an e-mail, log or SNMP trap after rebooting.
<b>Login Failed</b>	When unauthorized access from the console or Web interface occurs, a notification will be sent.
<b>IP Address Changed</b>	When the IP address of the device is changed, a notification will be sent.
<b>Password Changed</b>	When the password of the device is changed, a notification will be sent.

<b>Access IP Blocked</b>	When the host accesses the device with a blocked IP address, a notification will be sent.
<b>DCD Changed</b>	When a DCD (Data Carrier Detect) signal changes, indicating modem connection status has been changed, a notification will be sent.
<b>DSR Changed</b>	When a DSR (Data Set Ready) signal changes, indicating data communication equipment is powered off, a notification will be sent.
<b>RI Changed</b>	When a RI (Ring Indicator) signal changes, indicating there is an incoming call, a notification will be sent.
<b>CTS Changed</b>	When a CTS (Clear To Send) signal changes, indicating transmission between computer and DCE can proceed, a notification will be sent.
<b>Port Connected</b>	In TCP Server Mode, when the device accepts an incoming TCP connection, this event will be triggered. In TCP Client Mode, when the device has connected to the remote host, the event will be triggered. In Virtual COM Mode, when Virtual COM is ready to use, this event will be triggered. A notification will be sent when an event is triggered.
<b>Port Disconnected</b>	In TCP Server/Client Mode, when the device loses the TCP link, this event will be triggered. In Virtual COM Mode, when Virtual COM is not available, this event will be triggered. A notification will be sent when an event is triggered.

## 4.2.4 Save/Reboot

You can save current values from the device as a backup file or restore the device to previous settings by downloading a configuration file. Simply browse to the configuration file you want to use and click **Restore**.

Factory Default  
 Reset to default configuration.  
 Click Reset button to reset all configurations to the default value.

Restore Configuration  
 You can restore the previous saved configuration to Device Server.  
 File to restore:  未選擇任何檔案

Backup Configuration  
 You can save current EEPROM value from the Device Server as a backup file of configuration.

Upgrade Firmware  
 Specify the firmware image to upgrade.  
 Note: Please DO NOT power off this device while upgrading firmware.  
 Firmware:  選擇檔案 未選擇任何檔案  
  
 Reboot Device  
 Please click **[Reboot]** button to restart device.

Label	Description
<b>Factory Default</b>	Press <b>Reset</b> for five seconds (Hardware restore) and it will load default configurations to the system except the network settings..
<b>Restore Configuration</b>	Restore to previous settings using previously exported configurations.
<b>Backup Configuration</b>	Export the current configuration to a file.
<b>Upgrade Firmware</b>	Upgrade to a new firmware by browsing to a specific folder.
<b>Reboot Device</b>	Reboot the device server (warm start).

## 4.3 Configuration by SSH Console

### 4.3.1 Connect to DS

You can use SSH Tool (e.g., PUTTY) to access the SSH console of the device. The SSH console interface is shown below.

```
login as: admin
admin@192.168.0.39.'s password:

*****
*** ORING Industrial Serial Device Server Commander ***
*****
-----
[ORING Industrial Serial Device Server Commander]
1. Overview
2. General Settings
3. Network Settings
4. Ports settings
5. Security(Accessible IP) Settings
6. Notification(Auto Warning) Settings
C. Change Password
L. Load Factory Default
S. Save configuration
R. Reboot
Q. Exit & Logout

Select one function (1-6,C,L,S,R,Q): 
```

# Technical Specification

ORing Device Server Model		IDS-311F-MM	IDS-311F-SS
<b>Physical Ports</b>			
10/100 Base-T(X) Ports in RJ45 Auto MDI/MDIX		<b>1</b>	
Fiber Ports Specification	Fiber Ports Number	<b>1</b>	
	Fiber Ports standard	100Base-FX	
	Fiber Optical Connector	SC or ST	
	Fiber Mode	Multi-mode	Single-mode
	Fiber Diameter (μm)	62.5/125 μm 50/125 μm	9/125 μm
	Typical Distance (Km)	2 Km	30 Km
	Wavelength (nm)	1310 nm	1310 nm
	Max. Output Optical Power (dbm)	-14 dbm	-8 dbm
	Min. Output Optical Power (dbm)	-23.5 dbm	-15 dbm
	Max. Input Optical Power (Saturation)	0 dbm	0 dbm
	Min. Input Optical Power (Sensitivity)	-31 dbm	-34 dbm
	Link Budget (db)	7.5 db	19 db
	<b>Serial Ports</b>		
Connector	DB9 x 1		
Operation Mode	RS-232/422/485		
Serial Baud Rate	110 bps to 460.8 Kbps		
Data Bits	7, 8		
Parity	odd, even, none, mark, space		
Stop Bits	1, 1.5, 2		
RS-232	TxD, RxD, RTS, CTS, DTR, DSR, DCD, RI, GND		
RS-422	Tx-, Tx+, Rx+, Rx-		
RS-485	4 wire: Tx-, Tx+, Rx+, Rx- 2 wire: Data-, Data+		
Flow Control	XON/XOFF, RTS/CTS, DTR/DSR		
<b>Network Protocol</b>			
Protocol	ICMP, IP, TCP, UDP, DHCP, BOOTP, SSH, DNS, SNMP V1/V2c, HTTPS, SMTP		
<b>LED indicators</b>			
Power indicator	2 x LEDs, PWR 1(2) / Ready: Green On: Power is on		
10/100TX RJ45 port indicator (Eth1)	Green for port Link/Act		
100Base-FX Fiber Port Indicator (Eth2)	Green for port Link/Act		
Serial TX / RX LEDs:	Amber: Serial port is receiving data Green: Serial port is transmitting data		
<b>Power</b>			
Redundant Input power	Dual DC inputs. +12 to 48VDC on 4-pin terminal block		
Power consumption (Typ.)	3.98 W		
Overload current protection	Present		
Reverse polarity protection	Present on terminal block		

Physical Characteristic		
Enclosure	IP-30	
Dimension (W x D x H)	45 (W) x 81 (D) x 95 (H) mm	
Weight (g)	309g	
Environmental		
Storage Temperature	-40 to 85°C (-40 to 185°F)	
Operating Temperature	-40 to 70°C (-40 to 158°F)	
Operating Humidity	5% to 95% Non-condensing	
Regulatory approvals		
EMI	FCC Part 15, CISPR (EN55022) class A	
EMS	EN61000-4-2 (ESD), EN61000-4-3 (RS), EN61000-4-4 (EFT), EN61000-4-5 (Surge), EN61000-4-6 (CS), EN61000-4-8, EN61000-4-11	
Shock	IEC60068-2-27	
Free Fall	IEC60068-2-32	
Vibration	IEC60068-2-6	
Safety	EN60950-1	
Warranty		
5 years		
ORing Device Server Model	IDS-312	IDS-312+
Physical Ports		
10/100 Base-T(X) Ports in RJ45 Auto MDI/MDIX	2	
P.O.E.		P.O.E.Present at ETH1 Power Device (IEEE 802.3af): IEEE 802.3af compliant input interface Over load & short circuit protection Isolation Voltage: 1000 VDC min. Isolation Resistance : 10 <sup>8</sup> ohms min
Serial Ports		
Connector	DB9 x 1	
Operation Mode	RS-232/422/485	
Serial Baud Rate	110 bps to 460.8 Kbps	
Data Bits	7, 8	
Parity	odd, even, none, mark, space	
Stop Bits	1, 1.5, 2	
RS-232	TxD, RxD, RTS, CTS, DTR, DSR, DCD, RI, GND	
Flow Control	XON/XOFF, RTS/CTS, DTR/DSR	
Network Protocol		
Protocol	ICMP, IP, TCP, UDP, DHCP, BOOTP, SSH, DNS, SNMP V1/V2c, HTTPS, SMTP	
LED indicators		
Power indicator	3 x LEDs, PWR 1(2)(PoE) / Ready: Green On: Power is on	
10/100TX RJ45 port indicator	Green for port Link/Act at 100Mbps.	
Serial TX / RX LEDs:	Red: Serial port is receiving data Green: Serial port is transmitting data	
Power		
Redundant Input power	Dual DC inputs. 12-48VDC on 6-pin terminal block	Dual DC inputs. 12-48VDC on 6-pin terminal block IEEE 802.3af PoE PD (Eth 1)
Power consumption (Typ.)	3.36W	
Overload current protection	Present	
Reverse polarity protection	Present on terminal block	

Physical Characteristic	
Enclosure	IP-30
Dimension (W x D x H)	45 (W) x 81 (D) x 95 (H) mm
Weight (g)	304g <span style="float: right;">313g</span>
Environmental	
Storage Temperature	-40 to 85°C (-40 to 185°F)
Operating Temperature	-40 to 70°C (14 to 140°F)
Operating Humidity	5% to 95% Non-condensing
Regulatory approvals	
EMI	FCC Part 15, CISPR (EN55022) class A
EMS	EN61000-4-2 (ESD), EN61000-4-3 (RS), EN61000-4-4 (EFT), EN61000-4-5 (Surge), EN61000-4-6 (CS), EN61000-4-8, EN61000-4-11
Shock	IEC60068-2-27
Free Fall	IEC60068-2-32
Vibration	IEC60068-2-6
Safety	EN60950-1
Warranty	
	5 years

ORing Device Server Model	IDS-322	IDS-322+
Physical Ports		
10/100 Base-T(X) Ports in RJ45 Auto MDI/MDIX	2	
P.O.E.		P.O.E.Present at ETH1 Power Device (IEEE 802.3af): IEEE 802.3af compliant input interface Over load & short circuit protection Isolation Voltage: 1000 VDC min. Isolation Resistance : 10 <sup>8</sup> ohms min
Serial Ports		
Connector	DB9 x 2	
Operation Mode	RS-232/422/485	
Serial Baud Rate	110 bps to 460.8 Kbps	
Data Bits	7, 8	
Parity	odd, even, none, mark, space	
Stop Bits	1, 1.5, 2	
RS-232	TxD, RxD, RTS, CTS, DTR, DSR, DCD, RI, GND	
Flow Control	XON/XOFF, RTS/CTS, DTR/DSR	
Network Protocol		
Protocol	ICMP, IP, TCP, UDP, DHCP, BOOTP, SSH, DNS, SNMP V1/V2c, HTTPS, SMTP	
LED indicators		
Power indicator	3 x LEDs, PWR 1(2)(PoE) / Ready: Green On: Power is on	
10/100TX RJ45 port indicator	Green for port Link/Act at 100Mbps.	
Serial TX / RX LEDs:	Red: Serial port is receiving data Green: Serial port is transmitting data	
Power		
Redundant Input power	Dual DC inputs. 12-48VDC on 6-pin terminal block	Dual DC inputs. 12-48VDC on 6-pin terminal block IEEE 802.3af PoE PD (Eth 1)
Power consumption (Typ.)	3.84W	

Overload current protection	Present	
Reverse polarity protection	Present on terminal block	
<b>Physical Characteristic</b>		
Enclosure	IP-30	
Dimension (W x D x H)	45 (W) x 81 (D) x 95 (H) mm	
Weight (g)	316g	325g
<b>Environmental</b>		
Storage Temperature	-40 to 85°C (-40 to 185°F)	
Operating Temperature	-40 to 70°C (14 to 140°F)	
Operating Humidity	5% to 95% Non-condensing	
<b>Regulatory approvals</b>		
EMI	FCC Part 15, CISPR (EN55022) class A	
EMS	EN61000-4-2 (ESD), EN61000-4-3 (RS), EN61000-4-4 (EFT), EN61000-4-5 (Surge), EN61000-4-6 (CS), EN61000-4-8, EN61000-4-11	
Shock	IEC60068-2-27	
Free Fall	IEC60068-2-32	
Vibration	IEC60068-2-6	
Safety	EN60950-1	
<b>Warranty</b>	5 years	

<b>ORing Device Server Model</b>	<b>IDS-342</b>	<b>IDS-342+</b>
<b>Physical Ports</b>		
10/100 Base-T(X) Ports in RJ45 Auto MDI/MDIX	<b>2</b>	
P.O.E.		P.O.E.Present at ETH1 Power Device (IEEE 802.3af): IEEE 802.3af compliant input interface Over load & short circuit protection Isolation Voltage: 1000 VDC min. Isolation Resistance : 10 <sup>8</sup> ohms min
<b>Serial Ports</b>		
Connector	DB9 x 4	
Operation Mode	RS-232/422/485	
Serial Baud Rate	110 bps to 460.8 Kbps	
Data Bits	7, 8	
Parity	odd, even, none, mark, space	
Stop Bits	1, 1.5, 2	
RS-232	TxD, RxD, RTS, CTS, DTR, DSR, DCD, RI, GND	
Flow Control	XON/XOFF, RTS/CTS, DTR/DSR	
<b>Network Protocol</b>		
Protocol	ICMP, IP, TCP, UDP, DHCP, BOOTP, SSH, DNS, SNMP V1/V2c, HTTPS, SMTP	
<b>LED indicators</b>		
Power indicator	3 x LEDs, PWR 1(2)(PoE) / Ready: Green On: Power is on	
10/100TX RJ45 port indicator	Green for port Link/Act at 100Mbps.	
Serial TX / RX LEDs:	Red: Serial port is receiving data Green: Serial port is transmitting data	
<b>Power</b>		
Redundant Input power	Dual DC inputs. 12-48VDC on 6-pin terminal block	Dual DC inputs. 12-48VDC on 6-pin terminal block



		IEEE 802.3af PoE PD (Eth 1)
Power consumption (Typ.)	4.32W	
Overload current protection	Present	
Reverse polarity protection	Present on terminal block	
<b>Physical Characteristic</b>		
Enclosure	IP-30	
Dimension (W x D x H)	66 (W) x 81 (D) x 95 (H) mm	
Weight (g)	375g	384g
<b>Environmental</b>		
Storage Temperature	-40 to 85°C (-40 to 185°F)	
Operating Temperature	-40 to 70°C (14 to 140°F)	
Operating Humidity	5% to 95% Non-condensing	
<b>Regulatory approvals</b>		
EMI	FCC Part 15, CISPR (EN55022) class A	
EMS	EN61000-4-2 (ESD), EN61000-4-3 (RS), EN61000-4-4 (EFT), EN61000-4-5 (Surge), EN61000-4-6 (CS), EN61000-4-8, EN61000-4-11	
Shock	IEC60068-2-27	
Free Fall	IEC60068-2-32	
Vibration	IEC60068-2-6	
Safety	EN60950-1	
<b>Warranty</b>	5 years	